

REVISED BY: Lina.L
REVISÉ ON: [blank]
REVISÉ DATE: [blank]

PAGE NO: [blank]



6060 Boat Rock Blvd SW
Atlanta, GA 30336
www.dassoxttr.com
Tel: 1-404-691-6872

PRODUCT: Wood Pallet Type 1120

TITLE: Wood Pallet Type 1120

DRAWN BY: Lina.L DATE: Jan 01, 2018

SCALE: 1:1

CONTACT: 1-404-691-6872

FILE: EPC-LUM20-205-UF.DWG

PRINTED: [blank]

Thickness tolerance: ±1mm

Width tolerance: ±1mm

length tolerance: ±1mm

SAP V:
dasso XTR

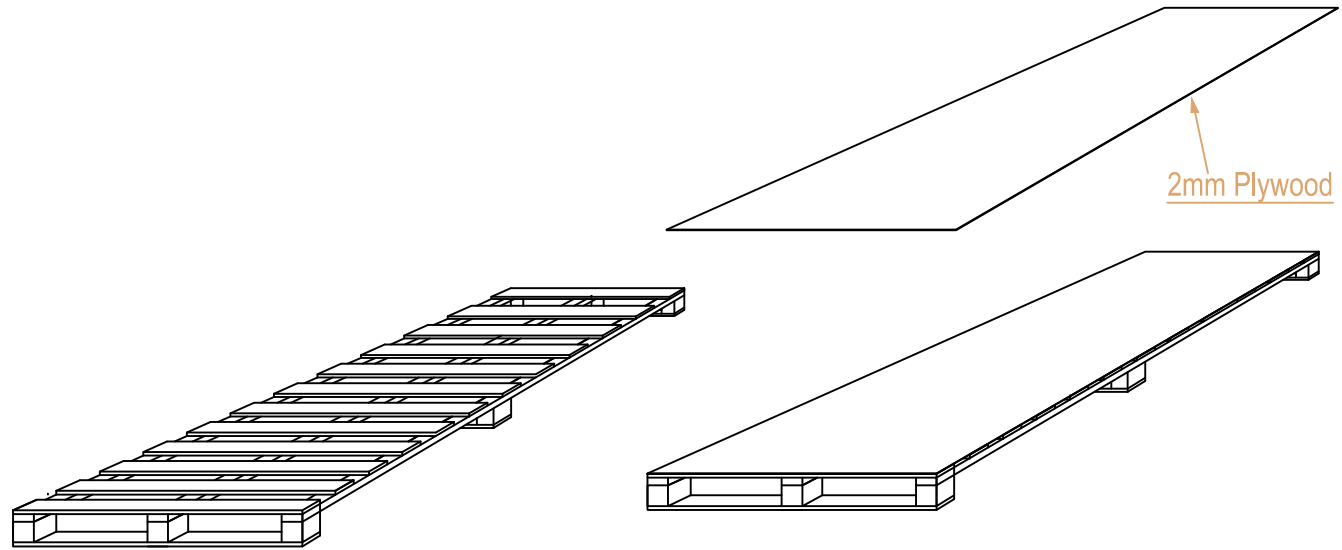

There are 4 band in the middle of the pallet

There are 4 belts out of the pallet: before packaging the 4 belts, the wrap film is at least three layers and ensure full of the decking.

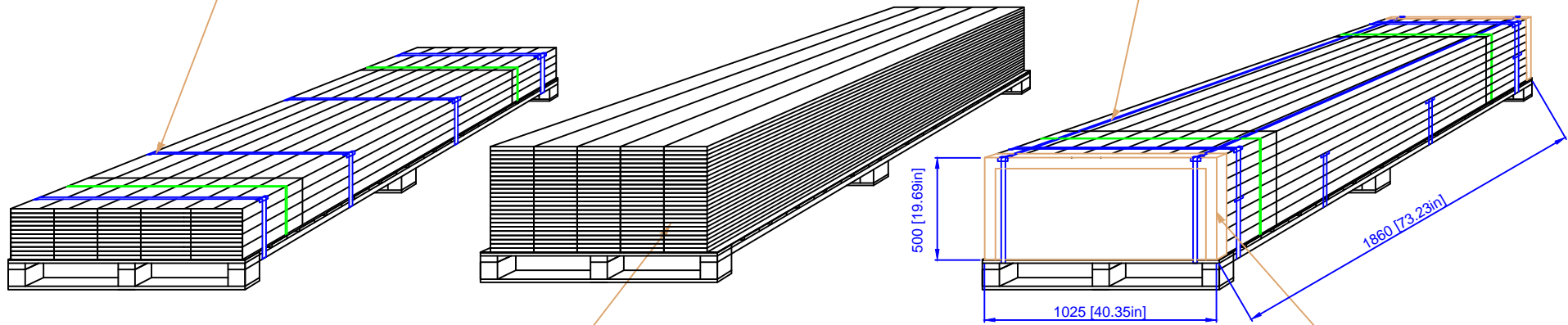

Layout: 5 rows x 25 layers

Corner guard on each corner

REVISED BY: Lina.L
REVISED DATE:

PAGE NO:

dassoXTR
Fused Bamboo® for Exterior Use

6060 Boat Rock Blvd SW
Atlanta, GA 30336
www.dassoxttr.com
Tel: 1-404-691-6872

PRODUCT: EPC-LUM20-205-UF

TITLE: Pallet Layout

DRAWN BY: Lina.L DATE: Jan 01, 2018

SCALE: 1:1

CONTACT: 1-404-691-6872

FILE: EPC-LUM20-205-UF.DWG

PRINTED:

Thickness tolerance: ±1mm

Width tolerance: ±1mm

length tolerance: ±1mm

SAP V:

dasso XTR

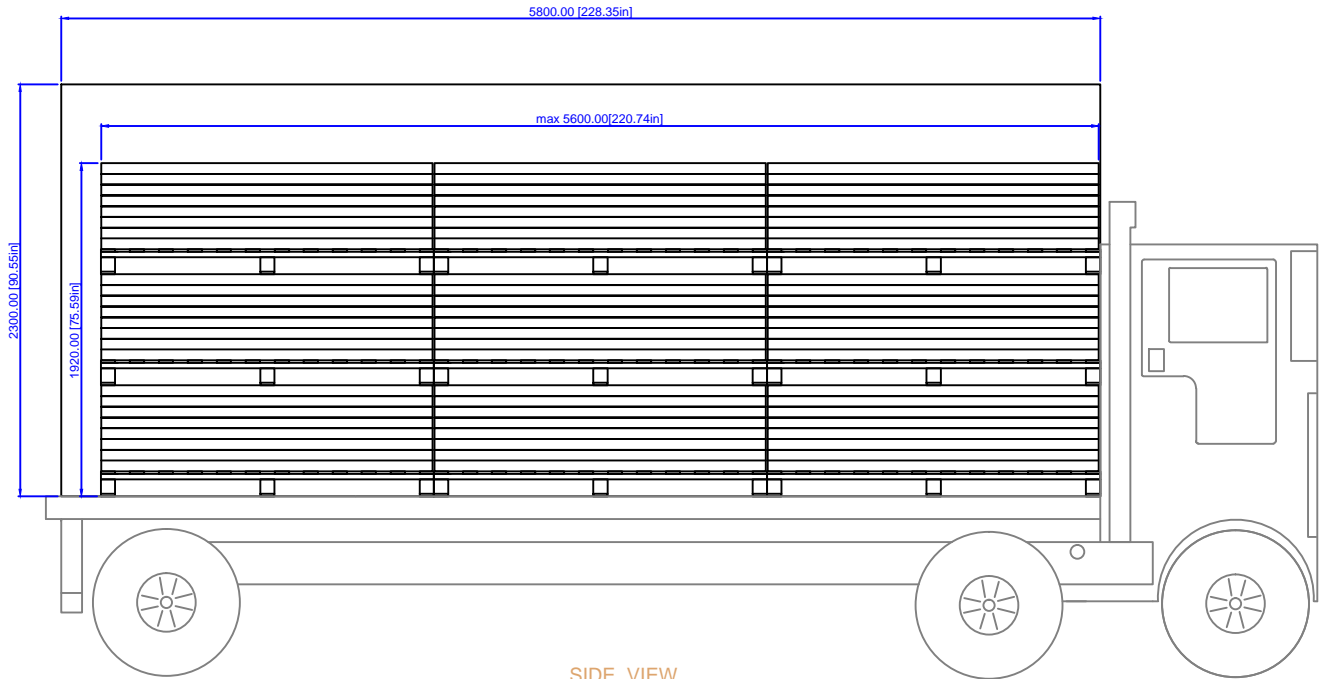

SIDE VIEW

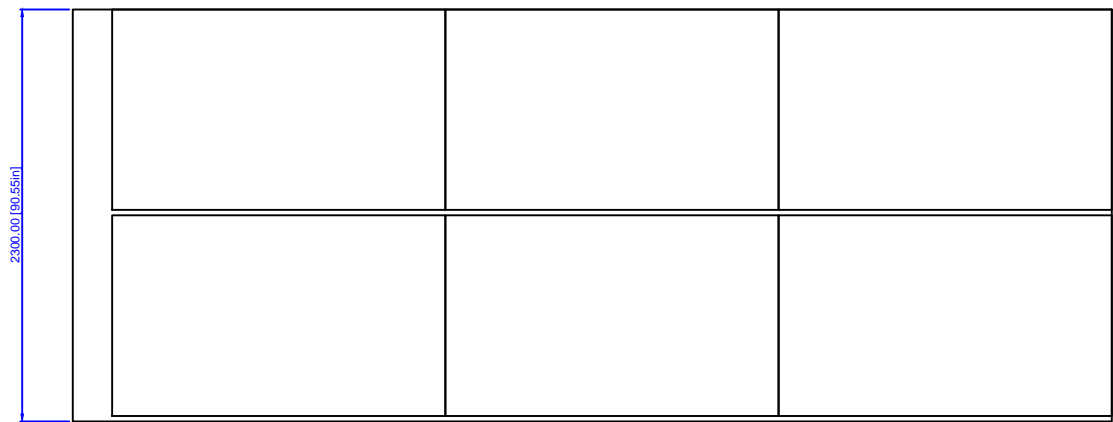

TOP VIEW

REVISED BY: Lina.L	REVISE ON: REVISED DATE:
SAP-V:	
dasso XTR	

PAGE NO:

dassoXTR
Fused Bamboo® for Exterior Use

6060 Boat Hook Blvd SW
Atlanta, GA 30336
www.dassoxt.com
Tel: 1-404-691-6872

PRODUCT: EPC-LUM20-205-UF			
TITLE: 20' Container Loading—18 Pallet Max			
DRAWN BY: Lina.L	DATE: Jan 01, 2018	SCALE: 1:1	CONTACT: 1-404-691-6872
FILE: EPC-LUM20-205-UF.DWG		PRINTED:	

Dimensions: Interior

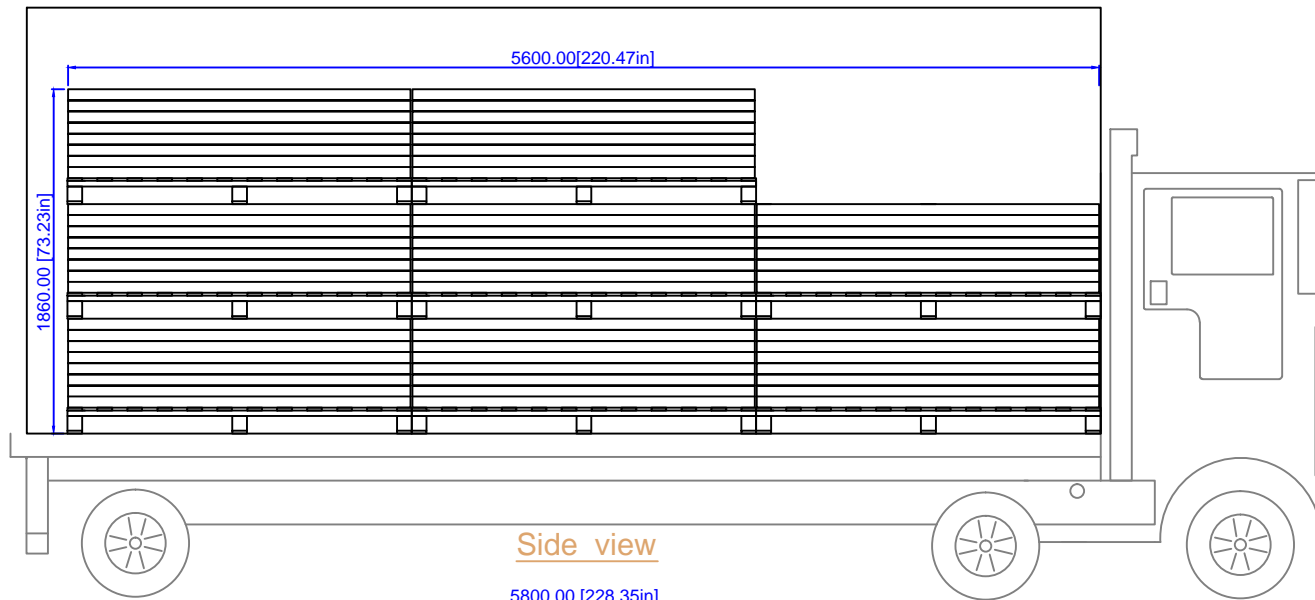

Side view

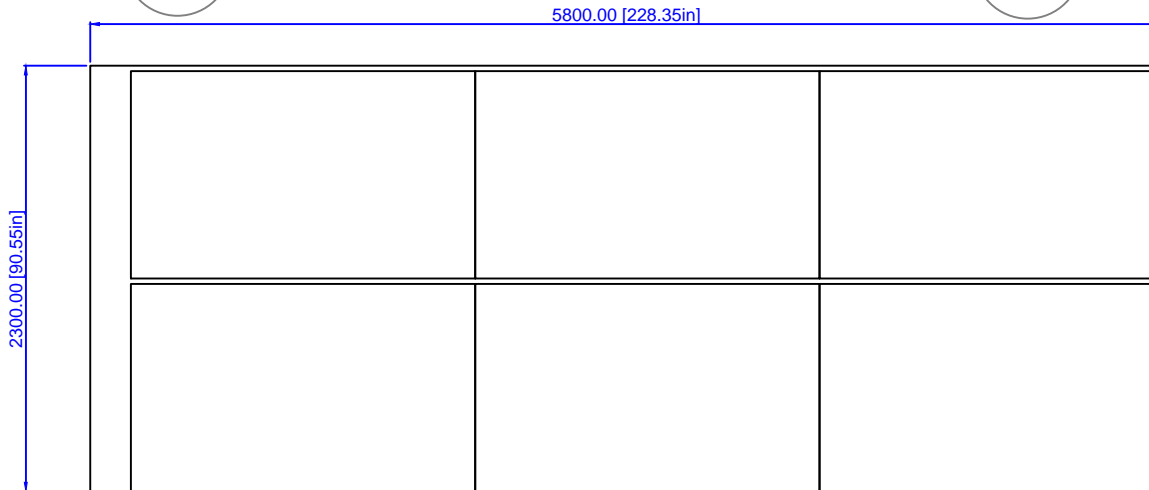

Top view

REVISED BY: Lina.L <small>REVISED DATE:</small>	REVISE ON:	PAGE NO.:	PRODUCT: EPC-LUM20-205-UF TITLE: 20' Container Loading—17 Pallet	Dimensions: Interior
SAP V: dasso XTR	 <small>Fused Bamboo® for Exterior Use</small> <small>6900 Boat Rock Blvd SW Atlanta, GA 30336 www.dassoxtf.com Tel: 1-404-691-6872</small>	DRAWN BY: Lina.L	DATE: Jan 01, 2018	SCALE: 1:1
			CONTACT: 1-404-691-6872	
			FILE: EPC-LUM20-205-UF.DWG	PRINTED: