

REVISED BY: Lina.L
REVISED DATE:

PAGE NO:

dassoXTR
Fused Bamboo® for Exterior Use

6060 Boat Rock Blvd SW
Atlanta, GA 30336
www.dassoxt.com
Tel: 1-404-691-6872

PRODUCT: Wood Pallet Type 950

TITLE: Wood Pallet Type 950

DRAWN BY: Lina.L DATE: Jan 01, 2018

SCALE: 1:1

CONTACT: 1-404-691-6872

FILE: EPC-LUM20-307F-PP.DWG

PRINTED:

Thickness tolerance: ±1mm

Width tolerance: ±1mm

length tolerance: ±1mm

SAP V:

dasso XTR

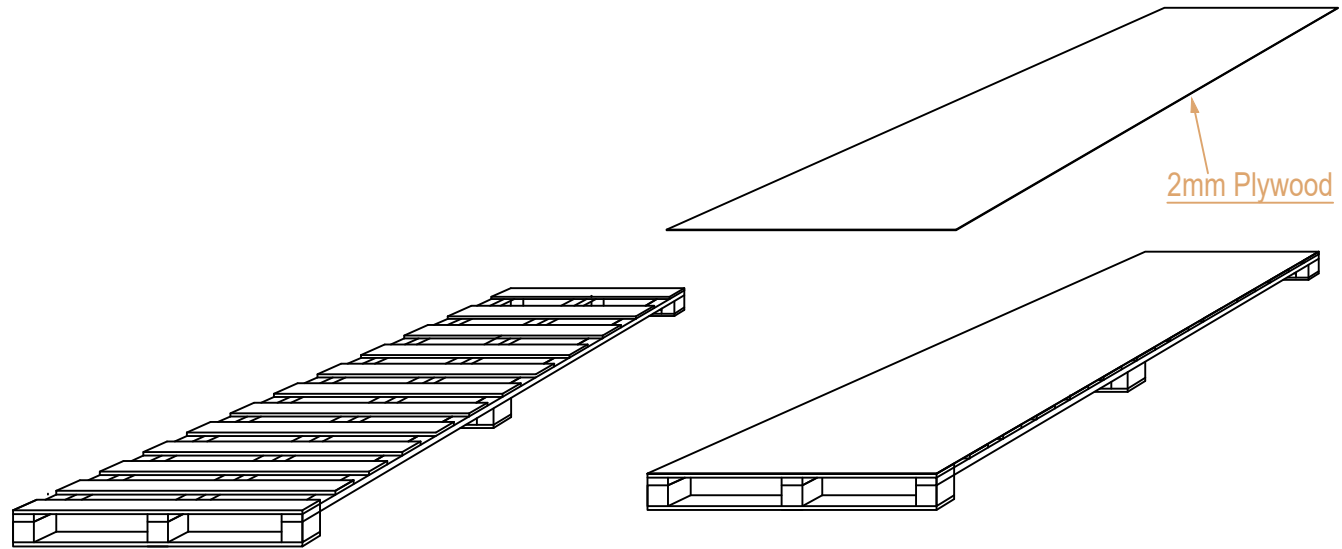

There are 4 band in the middle of the pallet

There are 4 belts out of the pallet: before packaging the 4 belts, the wrap film is at least three layers and ensure full of the decking.

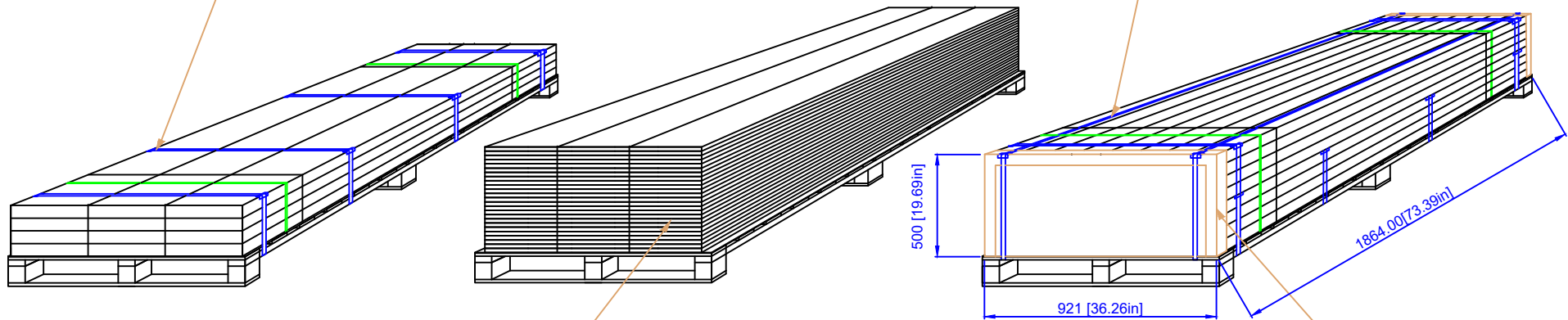

Layout: 3 rows x 25 layers

Corner guard on each corner

REVISED BY: Lina.L
REVISED DATE:

PAGE NO:



6000 Boat Rock Blvd SW
Atlanta, GA 30336
www.dassoxt.com
Tel: 1-404-691-6872

PRODUCT: EPC-LUM20-307F-PP

TITLE: Pallet Layout

DRAWN BY: Lina.L DATE: Jan 01, 2018

SCALE: 1:1

CONTACT: 1-404-691-6872

FILE: EPC-LUM20-307F-PP.DWG

PRINTED:

Thickness tolerance: ±1mm

Width tolerance: ±1mm

length tolerance: ±1mm

SAP V:
dasso XTR

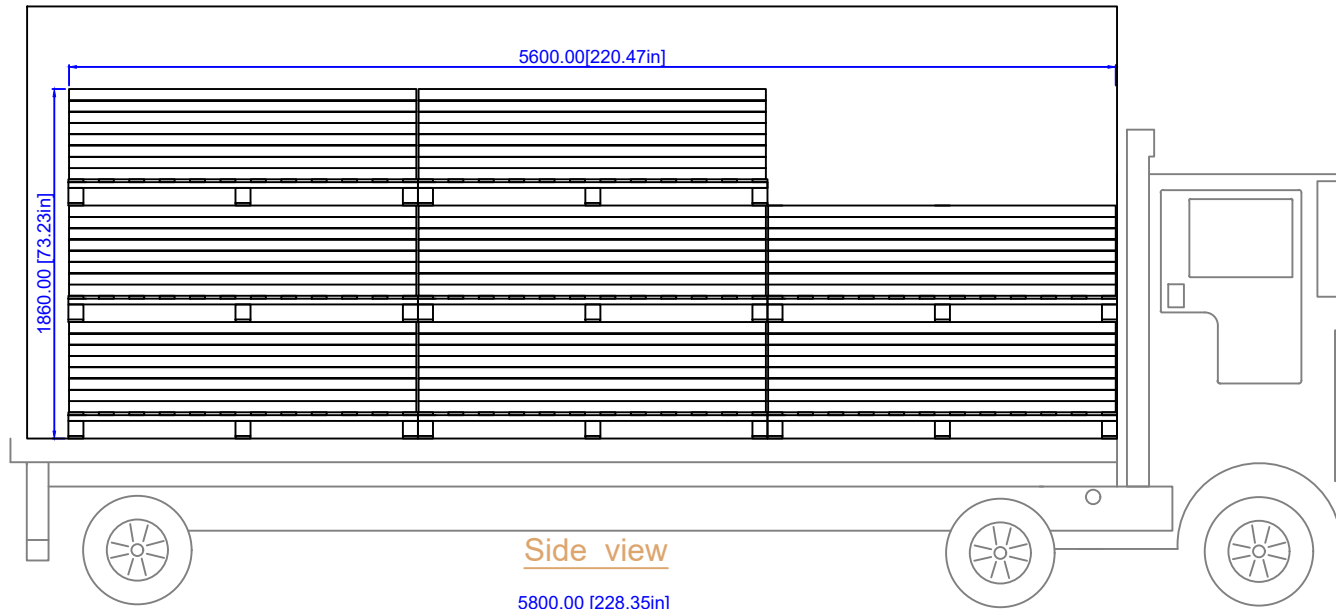

Side view

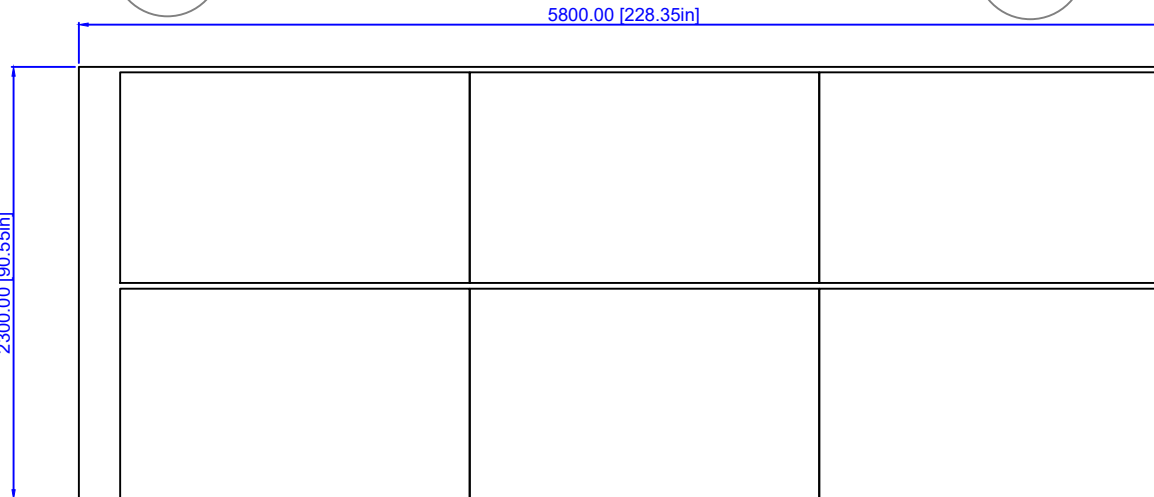

Top view

REVISED BY: Lina.L	REVISE ON:	PAGE NO.:	PRODUCT: EPC-LUM20-307F-PP			Dimensions: Interior
REVISED DATE:			TITLE: 20' Container Loading—17 Pallet			
SAP V:			DRAWN BY: Lina.L	DATE: Jan 01, 2018	SCALE: 1:1	CONTACT: 1-404-691-6872
dasso XTR	 Fused Bamboo® for Exterior Use <small>6060 Boat Rock Blvd SW Atlanta, GA 30336 www.dassoxtf.com Tel: 1-404-691-6872</small>		FILE: EPC-LUM20-307F-PP.DWG			PRINTED:

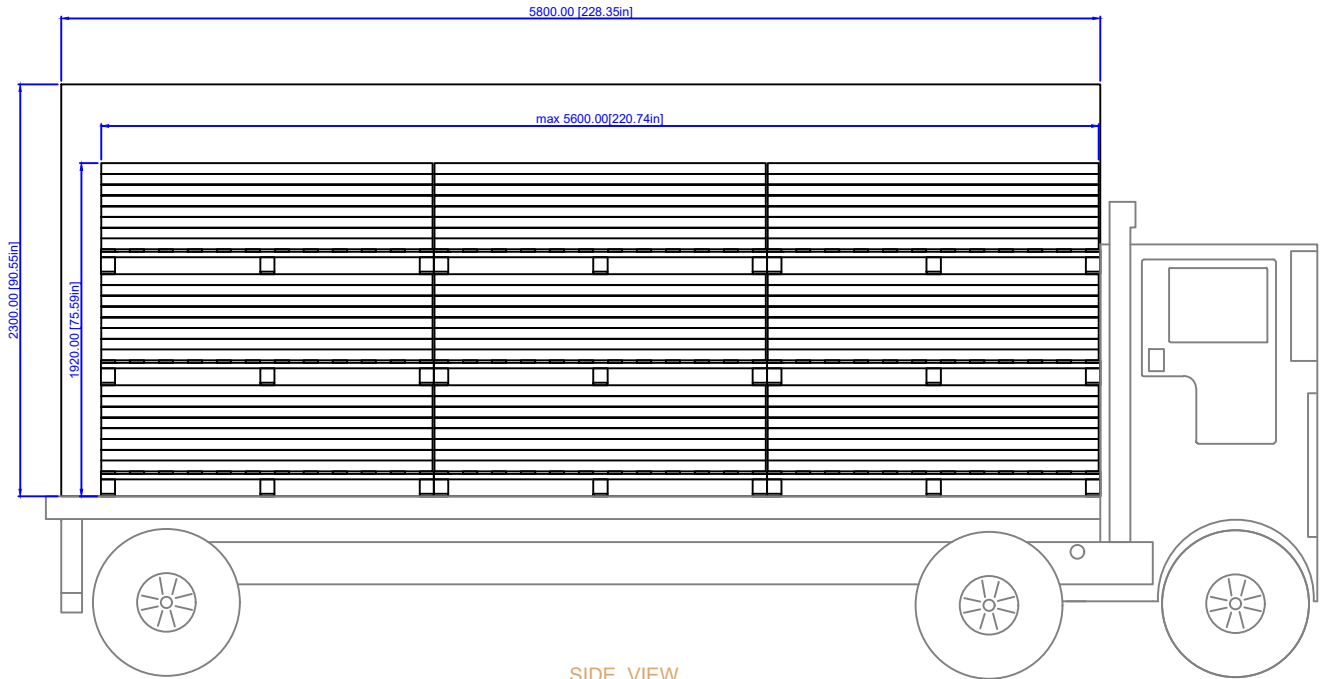

SIDE VIEW

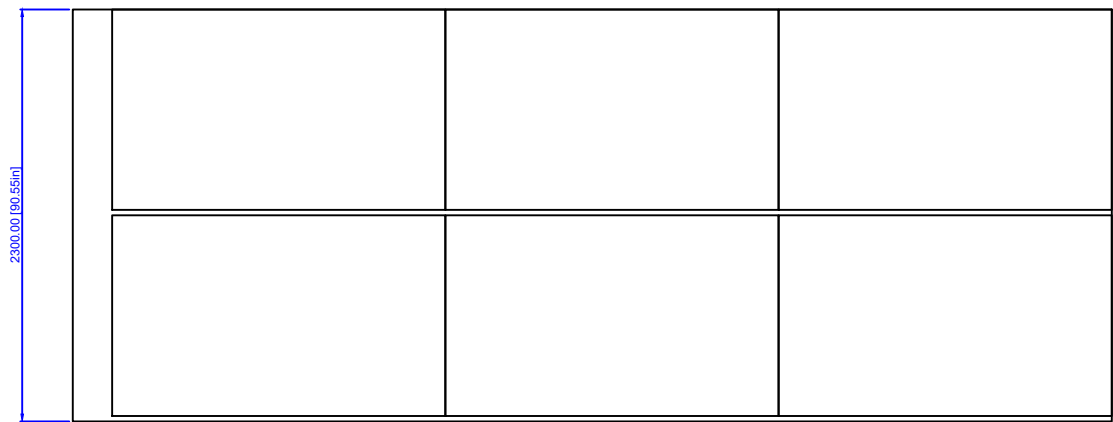

TOP VIEW

REVISED BY: Lina.L
 REVISION: REVISION ON: REVISION DATE:
 SAP-V:
 dasso XTR

PAGE NO:



PRODUCT: EPC-LUM20-307F-PP
 TITLE: 20' Container Loading—18 Pallet Max
 DRAWN BY: Lina.L DATE: Jan 01, 2018 SCALE: 1:1 CONTACT: 1-404-691-6872
 FILE: EPC-LUM20-307F-PP.DWG PRINTED:

Dimensions: Interior